

80 Axial fan
× 80 × 25mm



General Specifications

- Motor : Singal phase induction capacitor motor
- Frame & Impller :Al Die-casting & PBT plsatic
- Storage temperature : -40°C to +75°C
- Operating temperature : -10°C to +60°C

Major Characteristic Parameters

品牌	轴承	电压	频率	功率	转速	风量	静压	噪音		
型号	B/S	V	HZ	W	RPM	m3/mi n	CFM	mm-H2O	In-H2O	dba
SP80B11H-25AL	B/S	110	50/60	12/11	2500/3000	0.62/0.71	17/21	4.5/5.3	0.18/0.21	28/29
SP80B22H-25AL	B/S	220	50/60	12/11	2500/3000	0.62/0.71	17/21	4.5/5.3	0.18/0.21	28/29
SP80B11H-25AT	B/S	110	50/60	12/11	2500/3000	0.62/0.71	17/21	4.5/5.3	0.18/0.21	28/29
SP80B22H-25AT	B/S	220	50/60	12/11	2500/3000	0.62/0.71	17/21	4.5/5.3	0.18/0.21	28/29

*Bearing system B: Two Ball Bearing S: Sleeve Bearing

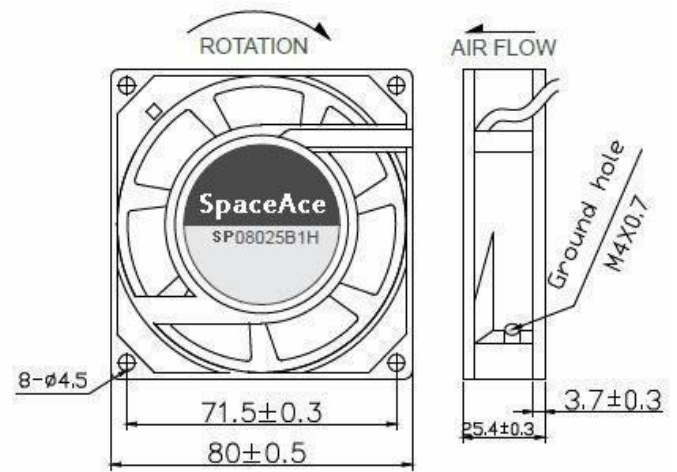
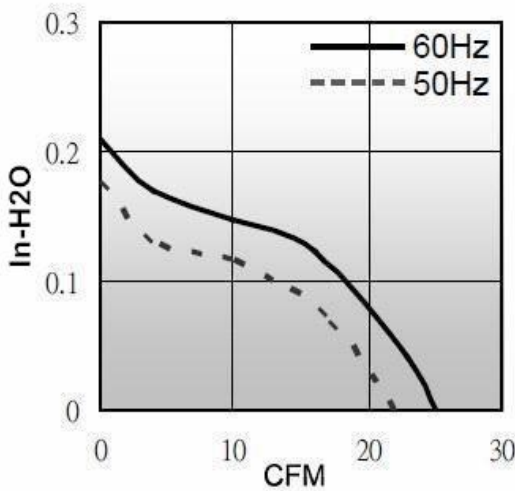

unit:mm